

HELIOS ACCESSORIES

CONTROL

SIMMERSTAT with Knob and Bezel
Panel Mount 16 amp

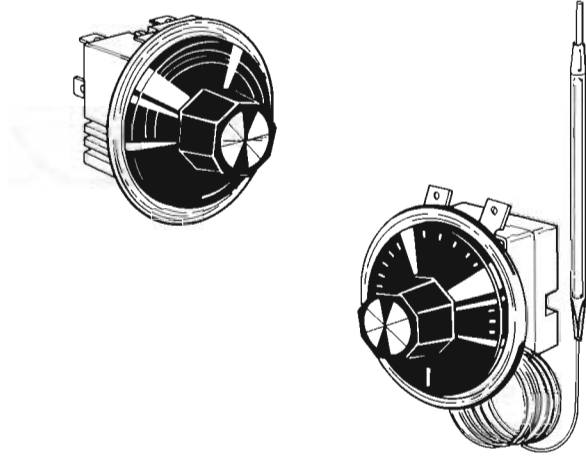

THERMOSTATS

Panel Mounted **16 amps**

0 – 40°C	} Single Phase
30 – 110°C	
50 – 300°C	
30 – 110°C	Three Phase 16 amp

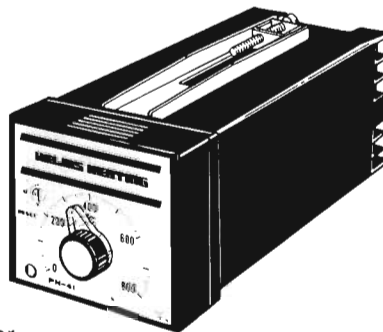

TEMPERATURE CONTROLLERS

Electronic Control 0 – 800°C Type K
Panel Mount – Cut out 65 x 65 mm

Also available Digital Set – with Deviation Indicator –
Digital Set with Digital read out. All controllers available Type J or Type K.

THERMOCOUPLES

Thermocouples Type K and Type J, Fibreglass Insulated-Stainless Steel
Armoured Sheath. Specify lead length and probe diameter and length.

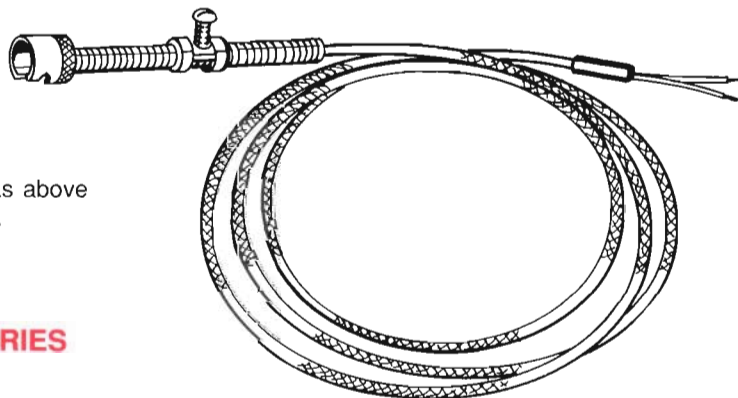
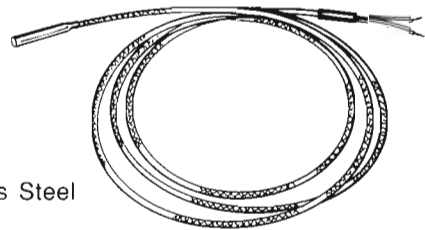

Thermocouples Type J and Type K as above
but with spring loaded Bayonet mount.

THERMOCOUPLE ACCESSORIES

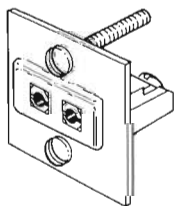

Socket Panel Mount

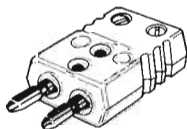

Plug

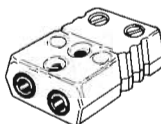

Line Socket



Bayonet Fitting Adaptor

HELIOS ACCESSORIES

HEAT RESISTANT CABLE



1. Multi Strand Nickel Conductors
2. Heavily Wrapped Glass Insulation
3. Silicone Bonded Heat Resistant Woven Glass

Stranding	Sectional Area	Amperage
16/0.20 mm	0.50 mm ²	2.0
24/0.20 mm	0.75 mm ²	4.5
32/.020 mm	1.00 mm ²	6.0
30/0.25 mm	1.50 mm ²	9.0
50/0.25 mm	2.50 mm ²	12.0
56/0.30 mm	4.00 mm ²	15.0

SILICONE RUBBER 3 CORE



Stranding	Sectional Area	Amperage
24/0.20 mm	0.75 mm ²	7.5
32/0.20 mm	1.00 mm ²	10.0
30/0.25 mm	1.50 mm ²	15.0

SLEEVING

BRAIDED GLASS SLEEVING (mm Dia.)

1.0, 1.5, 2.0, 3.0, 3.5, 4.0.

BRAIDED GLASS SLEEVING – Silicone Rubber (mm Dia.)

1.0, 1.5, 2.0, 2.5, 3.0, 3.5, 4.0, 5.0, 6.0, 7.0

HELIOS ACCESSORIES

PLUGS

European Plug Ceramic 25 amp

Right Angle

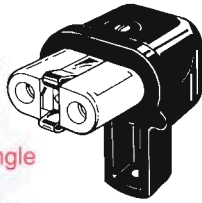

European Plug Silicone Rubber 16 amp

Straight

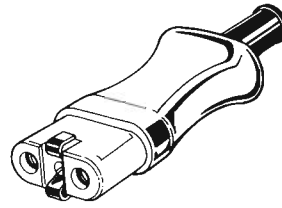

Nova Plug and Base
Three phase 16 amp

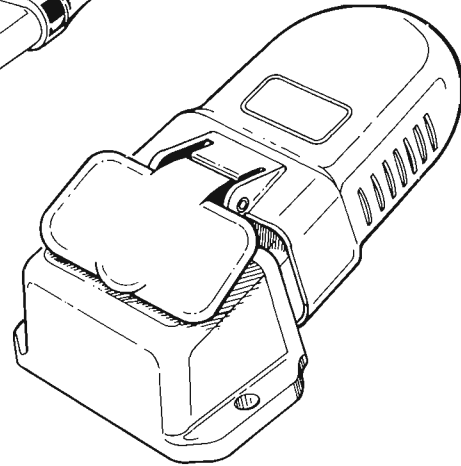

BASES AND JUNCTION BOXES

European Plug Base Right Angled

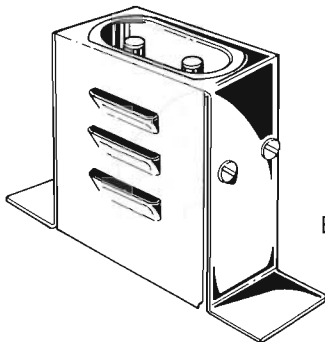
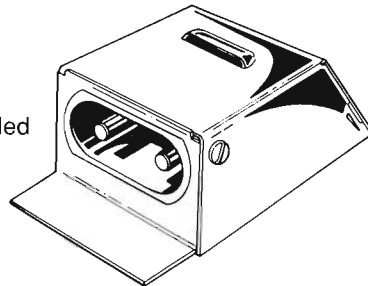

European Plug Base Straight

European Junction Box Right Angled

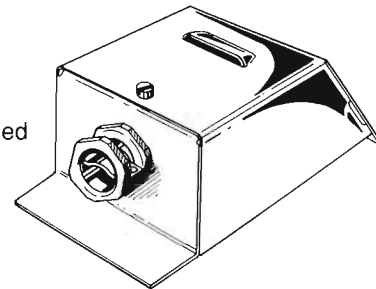

European Junction Box Straight

SPUN METAL JUNCTION BOXES

Powder Coated Mild steel O-Ring Seal
100 mm dia. 90 mm high
75 mm dia. 80 mm high

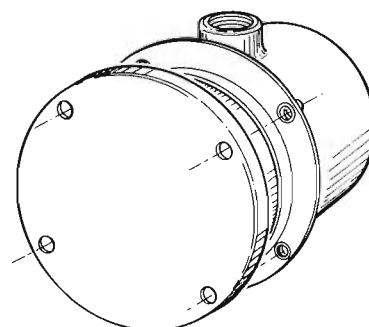

HELIOS ACCESSORIES

RELAY

Solid state relay suited to voltage pulsed
Temperature controllers
Input 3-32 volt D.C. Output 35 amps for resistive loads.
Dimensions 60 x 35 x 20 mm high

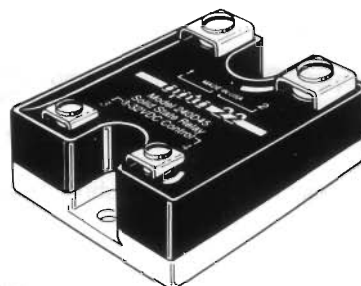

JUNCTION BLOCKS

Ceramic Block 2 way 20 amp
30 x 40 x 20 high. Max 250°C

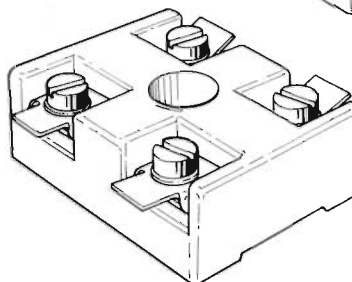

CERAMIC BLOCK 2 WAY 30 amp

65 x 35 x 25 high. Max 100°C.

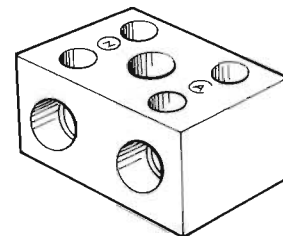

CERAMIC BLOCK 3 WAY 30 amp

60 x 30 x 25 high. Max 100°C

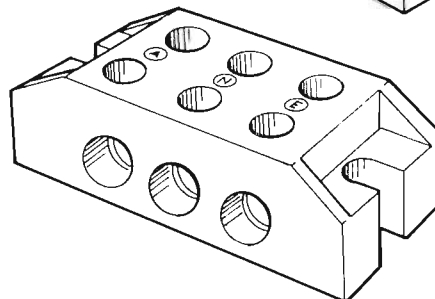

CERAMIC BLOCK 4 WAY 30 amp

65 x 35 x 25 high. Max 100°C

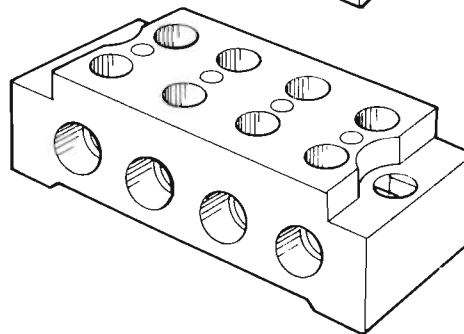

INSULATION

High temperature **thermal** insulation to 1300°C
Ceramic Fibre Board 6.5 mm thick
Ceramic Fibre Blanket 3.0 mm thick
Ceramic Fibre Wool 25 mm thick

High Temperature **electrical** insulation to 400°C
Rigid Mica Board 0.4 mm, 0.5 mm thick 1000 mm x 1200 mm